



| | | | |
|---|---|------------|--|
| MATERIALE | | ANTAL | Tages Tegnesteue tagflaz@gmail.com |
| Fyr + MDF | | 1 | |
| OVERFLADE | | KG. STK. | BENÆVNELSE |
| Lakeres 9010 | | 6.77 | Vitrin-kasse |
| EN1090 | INIT | DATO | PROJEKT |
|  |  | TFB | 17-02-2022 |
| FORMAT | SCALE | REVISION | TEGN.NR. |
| A4 | 1:7.5 | 17-02-2022 | 1501-000-000 |



DETAIL A
SCALE 1 : 3

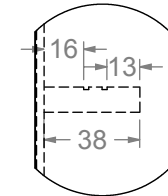
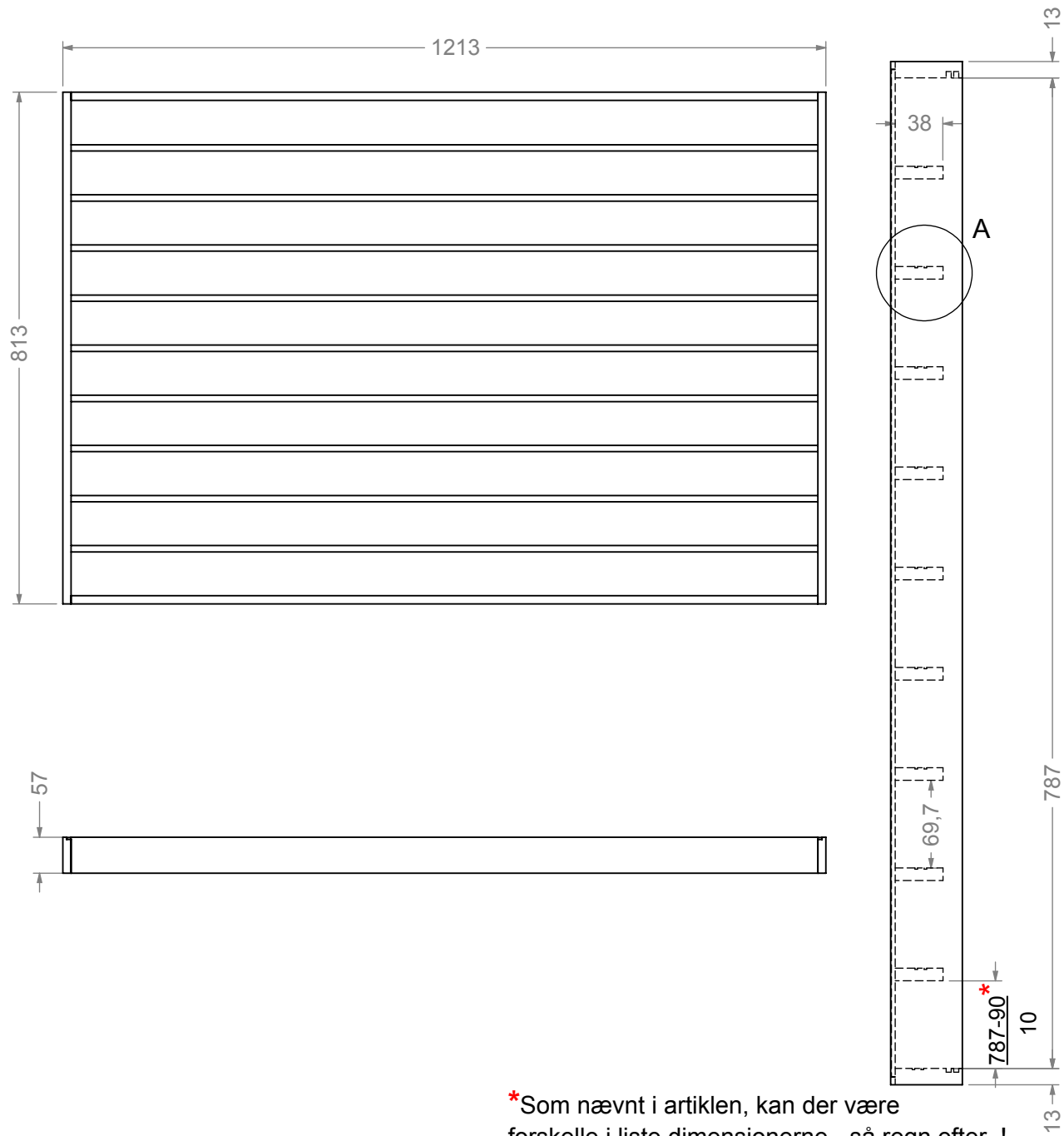
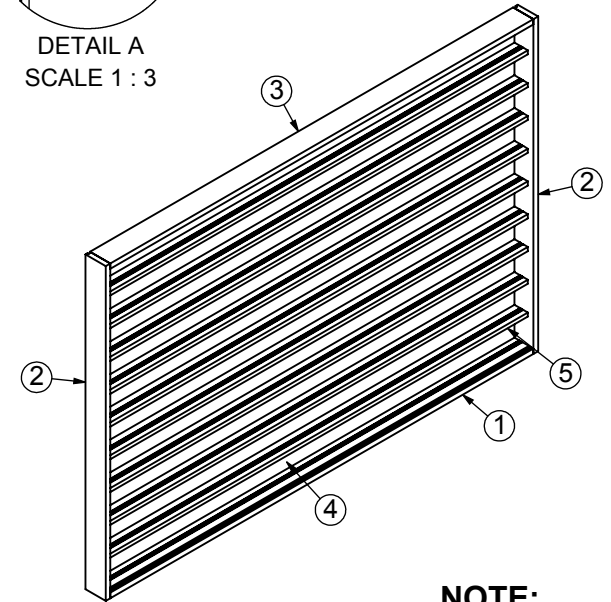

NOTE:
Låger ikke vist

| Pos | Stk | Benævnelse | Tegn/varenr |
|-----|-----|------------|--------------|
| 1 | 1 | Bundstykke | 1501-100-002 |
| 2 | 2 | Sidestykke | 1501-100-003 |
| 3 | 1 | Topstykke | 1501-100-001 |
| 4 | 1 | Bagplade | 1501-100-005 |
| 5 | 9 | Hylde | 1501-100-004 |

| | | | |
|----------------------------------|-------------------------|-----------------------------------|---|
| MATERIALE Fyr + MDF | | ANTAL 1 | Tages Tegnestue tagflaz@gmail.com |
| OVERFLADE Lakeres 9010 | KG. STK. 3.29 | BENÆVNELSE Vitrin-kasse | |
| EN1090 | INIT TFB | DATO 17-02-2022 | PROJEKT Togvitrine |
| FORMAT A4 | SCALE 1:15 | REVISION 17-02-2022 | TEGN.NR. 1501-000-001 |

*Som nævnt i artiklen, kan der være forskelle i liste dimensionerne - så regn efter..!

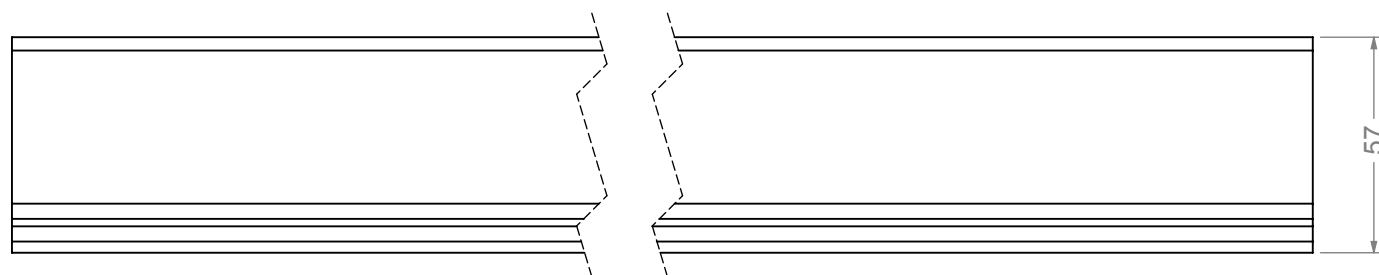
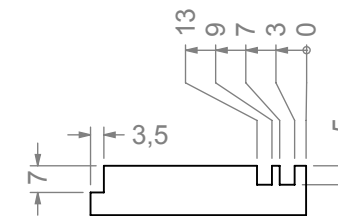
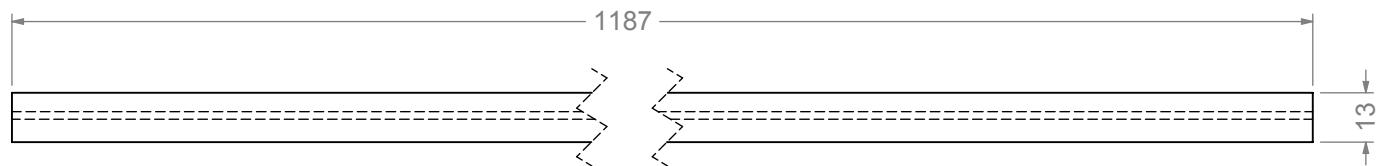

OBS
 Dimensionsmålene (57 x 13)
 skal tages med forbehold
 jvnf. artiklen.

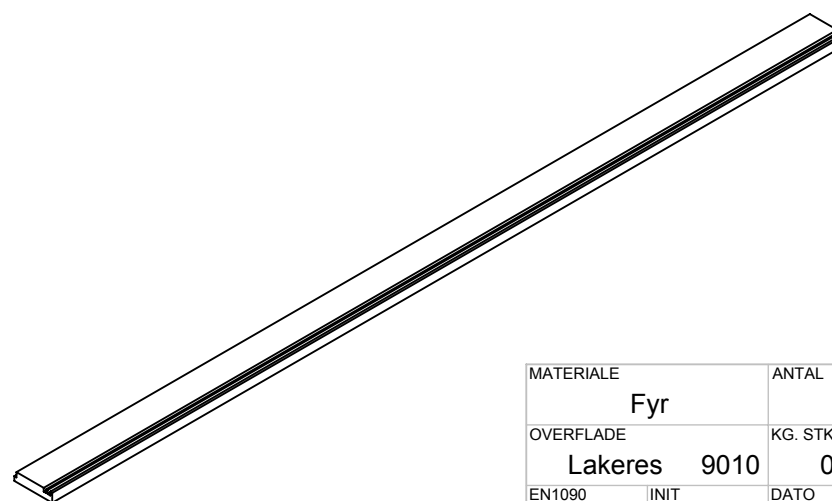

| | | | | |
|-----------|--------------|----------|------------|---|
| MATERIALE | Fyr | ANTAL | 1 | Tages Tegnestue tagflaz@gmail.com |
| OVERFLADE | Lakeres 9010 | KG. STK. | 0.27 | |
| EN1090 | INIT | DATO | PROJEKT | TEGN.NR. 1501-100-001 |
| FORMAT | SCALE | REVISION | TEGN.NR. | |
| | A4 | 1:2 | 17-02-2022 | |

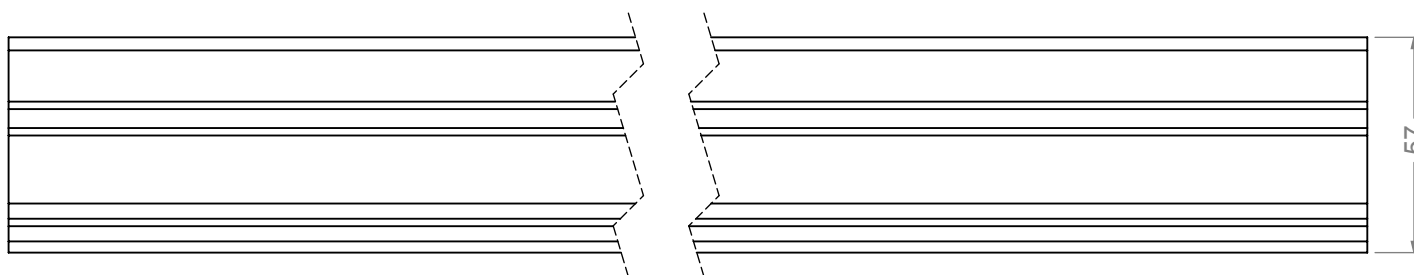
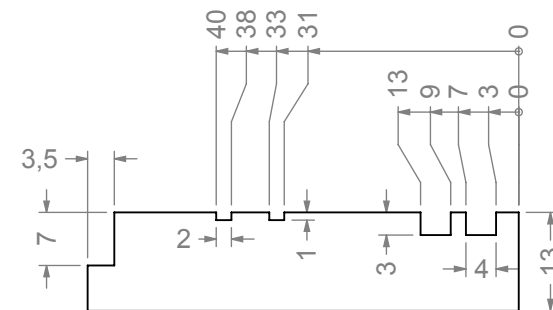
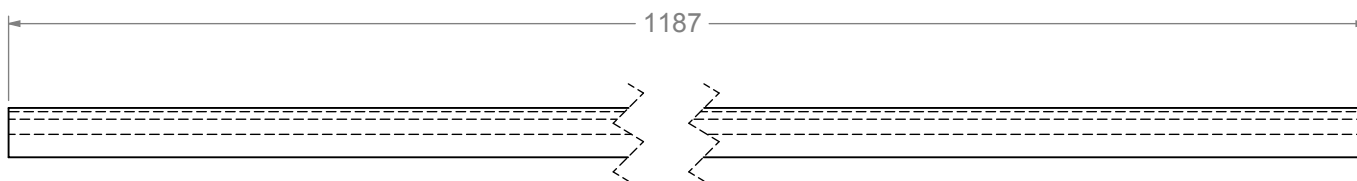

OBS
 Dimensionsmålene (57 x 13)
 skal tages med forbehold
 jvnf. artiklen.

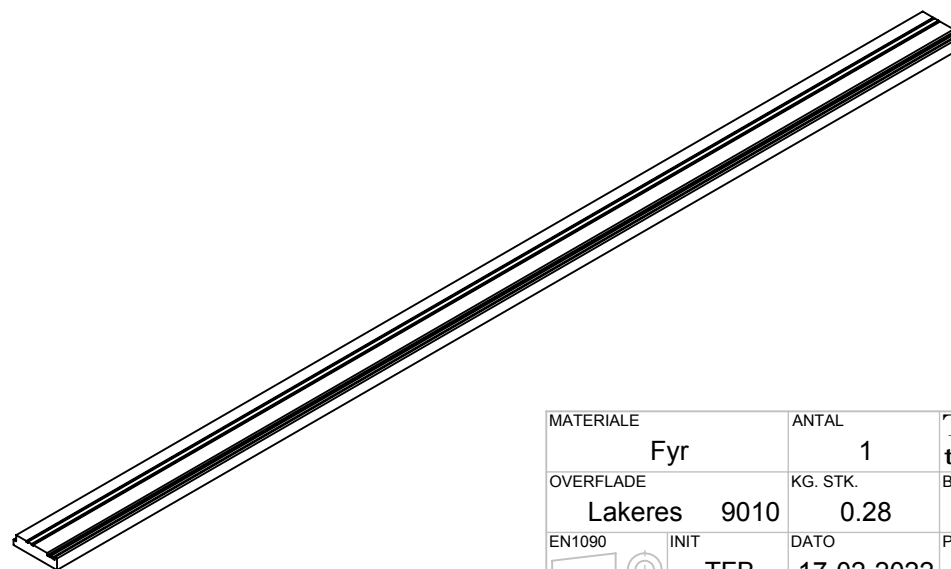

| | | | | |
|-----------|--------------|------------|------------|--|
| MATERIALE | Fyr | ANTAL | 1 | Tages Tegnesteue tagflaz@gmail.com |
| OVERFLADE | Lakeres 9010 | KG. STK. | 0.28 | |
| EN1090 | INIT | DATO | PROJEKT | TEGN.NR. 1501-100-002 |
| FORMAT | SCALE | REVISION | 17-02-2022 | |
| A4 | 1:2 | 17-02-2022 | | |

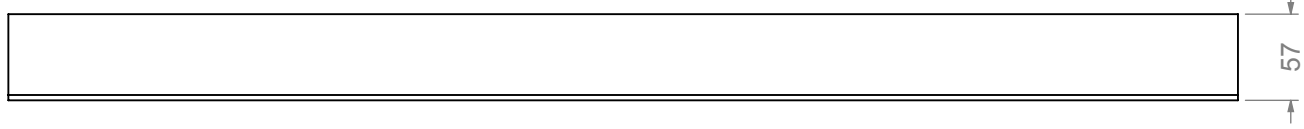
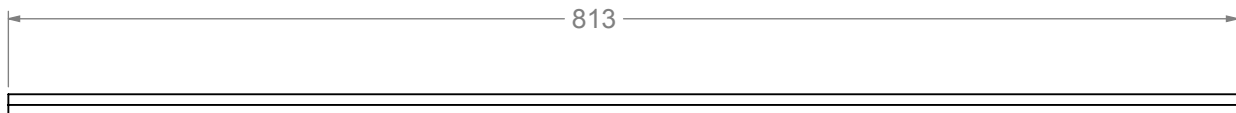

OBS
 Dimensionsmålene (57 x 13)
 skal tages med forbehold
 jvnf. artiklen.

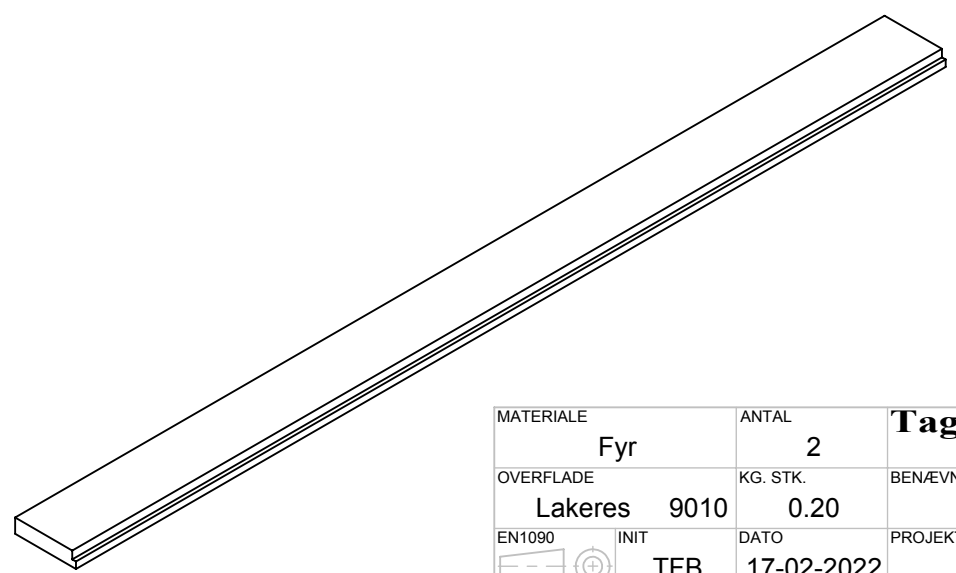

| | | | |
|--------------|-------|------------|---|
| MATERIALE | | ANTAL | Tages Tegnestue tagflaz@gmail.com |
| Fyr | | 2 | |
| OVERFLADE | | KG. STK. | BENÆVNELSE |
| Lakeres 9010 | | 0.20 | Sidestykke |
| EN1090 | INIT | DATO | PROJEKT |
| | TFB | 17-02-2022 | Togvitrine |
| FORMAT | SCALE | REVISION | TEGN.NR. |
| A4 | 1:5 | 17-02-2022 | 1501-100-003 |

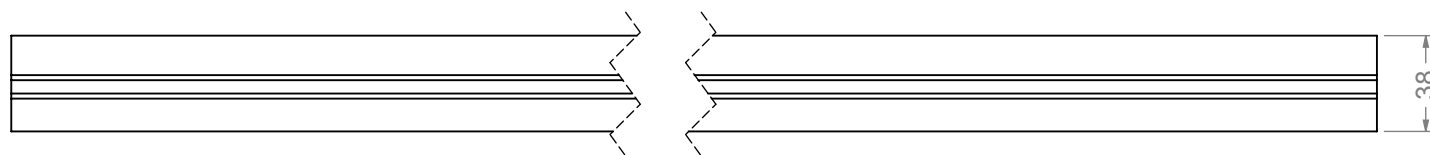
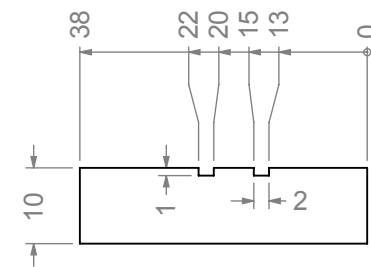
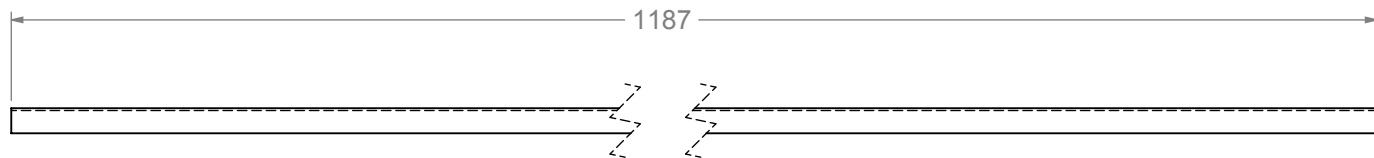

OBS
 Dimensionsmålene (38 x 10)
 skal tages med forbehold
 jvnf. artiklen.

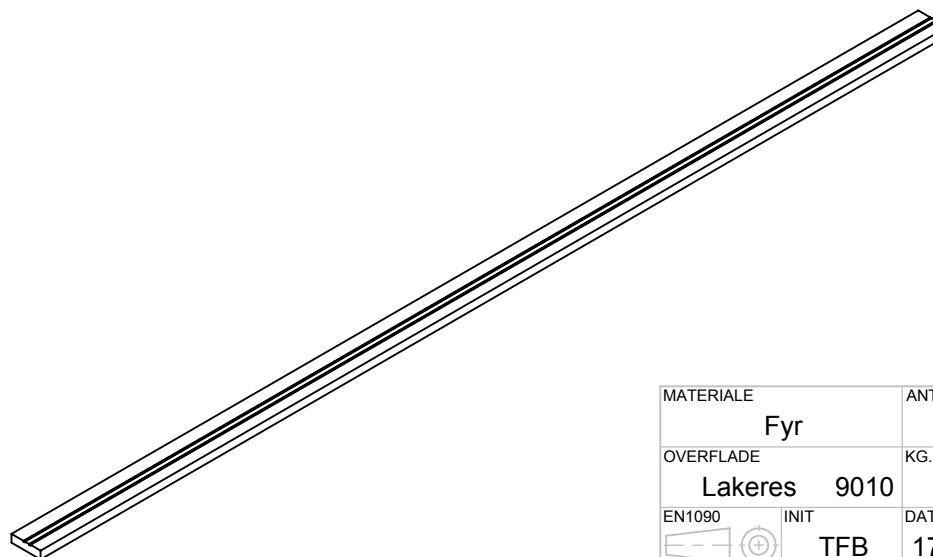

| | | | | |
|-----------|--------------|----------|------------|--|
| MATERIALE | Fyr | ANTAL | 9 | Tages Tegnesteue tagflaz@gmail.com |
| OVERFLADE | Lakeres 9010 | KG. STK. | 0.15 | BENÆVNELSE Hyldestykke |
| EN1090 | INIT | DATO | 17-02-2022 | PROJEKT Togvitrine |
| FORMAT | A4 | SCALE | 1:3 | TEGN.NR. 1501-100-004 |



| | | | |
|---|-------|------------|--|
| MATERIALE | | ANTAL | Tages Tegnesteue tagflaz@gmail.com |
| PDF | | 1 | |
| OVERFLADE | | KG. STK. | BENÆVNELSE |
| Lakeres 9010 | | 0.98 | Bagstykke |
| EN1090 | INIT | DATO | PROJEKT |
|  | TFB | 17-02-2022 | Togvitrine |
| FORMAT | SCALE | REVISION | TEGN.NR. |
| A4 | 1:10 | 17-02-2022 | 1501-100-005 |

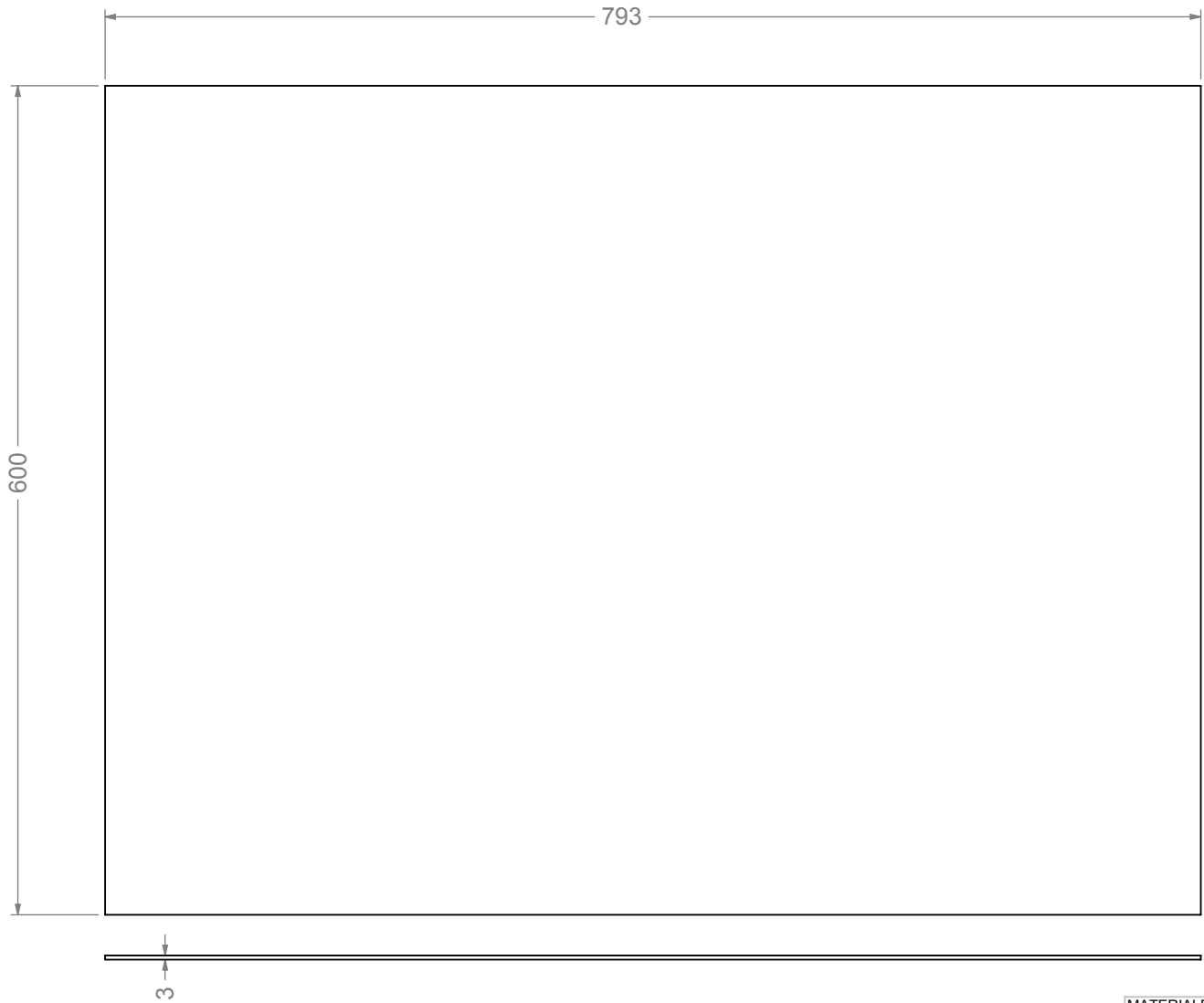

| | | | |
|--------------------------------|---------------------|-------------------------------|--|
| MATERIALE Acryl | | ANTAL 2 | Tages Tegnesteue tagflaz@gmail.com |
| OVERFLADE Ubehandlet | | KG. STK. 1.71 | BENÆVNELSE Låge |
| EN1090 | INIT TFB | DATO 17-02-2022 | PROJEKT Togvitrine |
| FORMAT A4 | SCALE 1:5 | REVISION 17-02-2022 | TEGN.NR. 1501-100-006 |